

Lookout Loft 8-Level Cat Tree

Assembly Instructions

Thank you for your purchase. Follow these step-by-step instructions to properly assemble your Lookout Loft 8-Level Cat Tree.

Max weight limit
65 LB
(29.5 kg)

Be a good pet parent, read care guides, books, and research quality care for your pet. Contact a pet professional with any additional care questions.

For questions and inquiries, please contact our customer service line at 1-888-824-7257. For online orders, contact us at 1-877-738-6742, or visit us at petco.com.

Completed Cat Tree

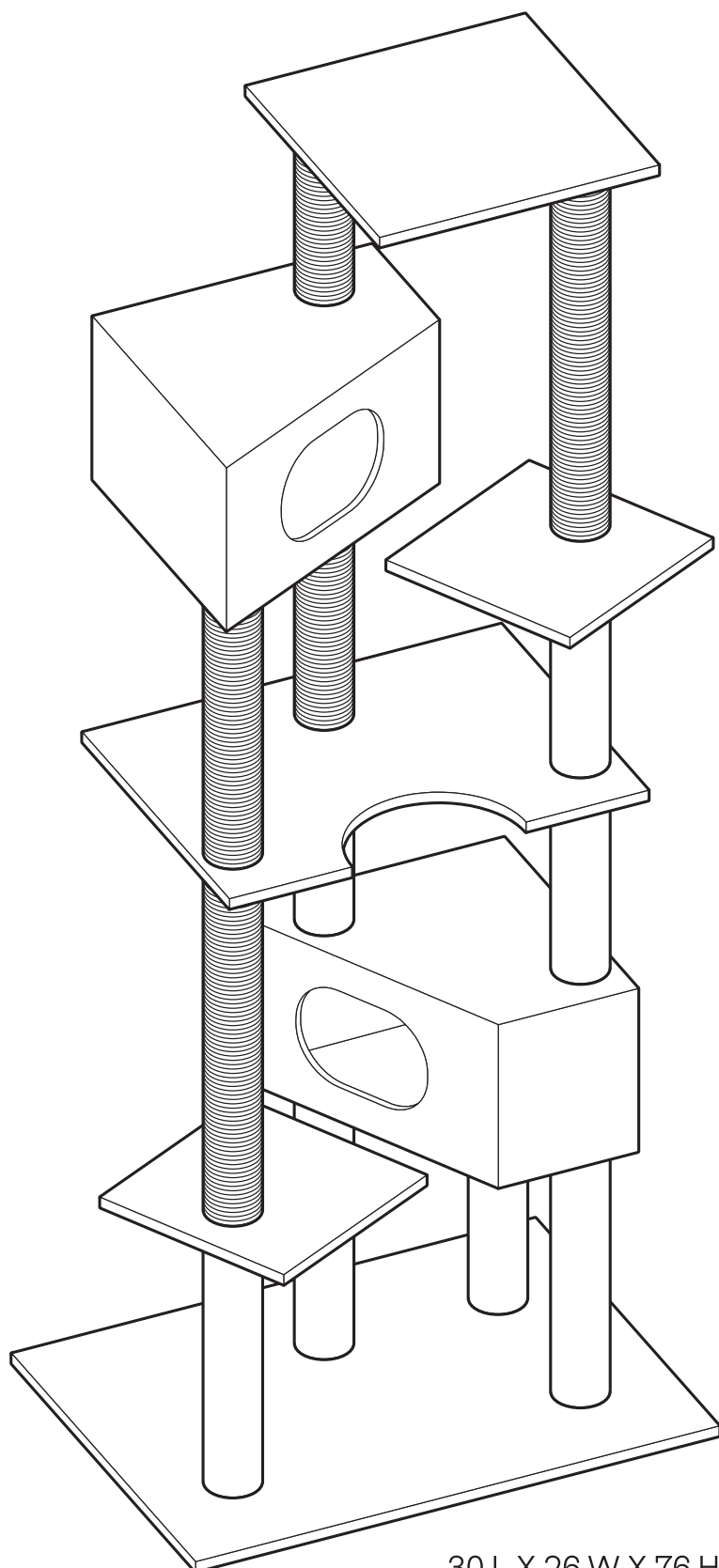

30 L X 26 W X 76 H IN
(76 L X 66 W X 193 H CM)

Max Weight Limit 65 LB (29.5 kg)

Due to ongoing product improvements, product photo on packaging may not match finished product.

⚠️ WARNING

- Read and follow all warnings and instructions in this manual to avoid personal injury to pet or property damage.
- For pet use only. Not suitable for children.
- To avoid damage, do NOT assemble horizontally on the floor and lift to an upright position. Assemble product vertically as down in instructions.
- Wall mount is required.
- For additional stability, we recommend placing product against a wall or corner.
- Do not exceed maximum weight limit.
- Inspect product regularly and re-tighten screws as necessary.
- Always supervise your pet when using this item.
- Inspect product for damage and discard if any part becomes worn, loose or detached.
- Not recommended for outdoor use.
- Keep all tools and instructions in a safe place for future reference.

CAUTION: FOR PET USE ONLY. NOT SUITABLE FOR CHILDREN.

Inspect regularly and discard if any part becomes damaged. Do not exceed weight limit. Not recommended for outdoor use. Do not allow children to climb on or hang from furniture. Check all hardware and connections regularly to tighten as needed.

CARE INSTRUCTIONS

Spot clean only and vacuum when necessary.

Lookout Loft 8-Level Cat Tree—Assembly Instructions

When assembling your cat tree, place on a flat, stable surface. Assemble vertically, starting on the base.

Loose components will result in damage to the cat tree. Ensure all screws are secure and tighten them again after two days. Check that screws are secure once a month to ensure product's stability.

Parts List

Tools needed are included. Check that you have all the parts shown BEFORE assembling your product. If any parts are missing, call Customer Service.

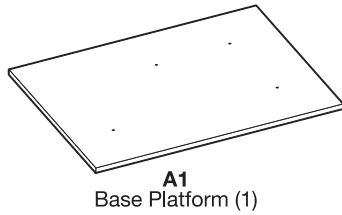

A1
Base Platform (1)

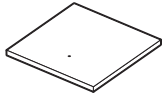

A2
Perch Platform (1)

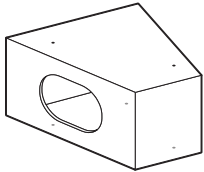

A3
Bottom Cubby (1)

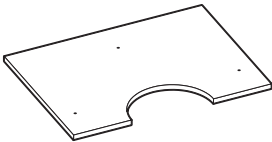

A4
Mid Platform (1)

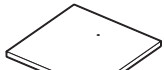

A5
Perch Platform (1)

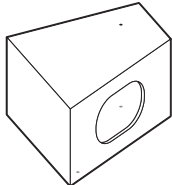

A6
Top Cubby (1)

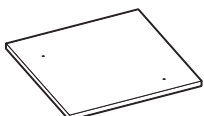

A7
Top Platform (1)



C5
Screw (1)



C6
Screw Anchor (1)



C7
Washer (1)

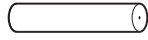

B1
Plush Post (4)

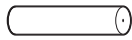

B2
Plush Post (1)

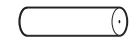

B3
Plush Post (2)



B4
Jute-wrapped Post (1)

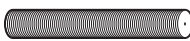

B5
Jute-wrapped Post (1)



B6
Jute-wrapped Post (2)



B7
Jute-wrapped Post (1)

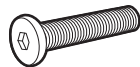

C1
Post Hex Bolt (14)



C2
Hex Bolt Wrench (1)



C3
Double-sided Bolt (5)

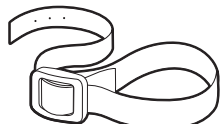

C4
Strap (1)

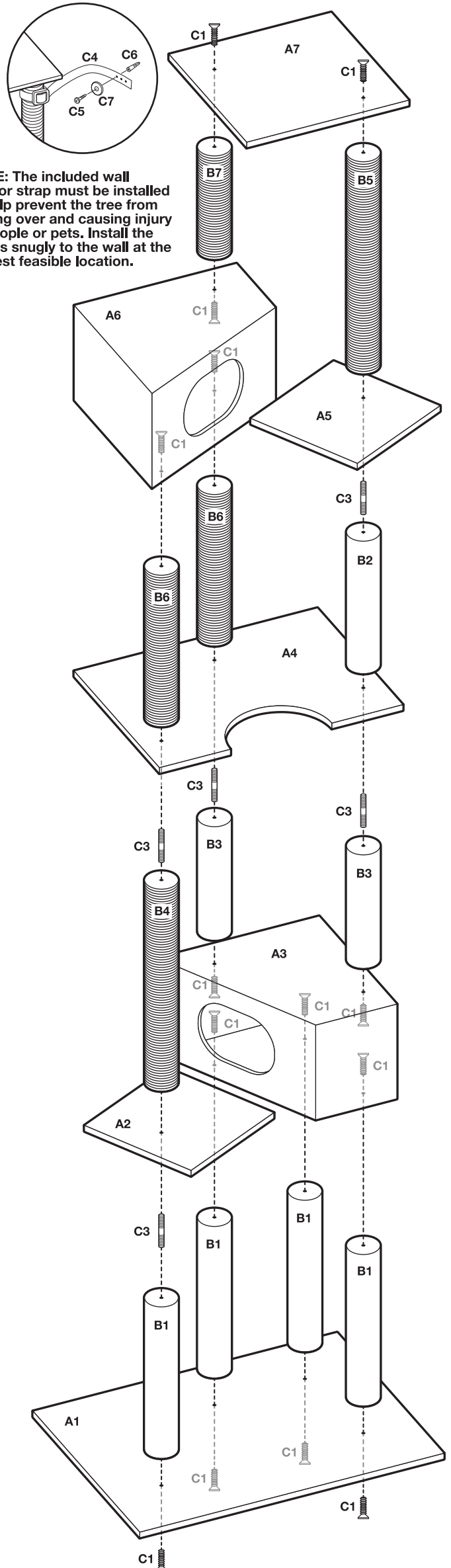

NOTE: The included wall anchor strap must be installed to help prevent the tree from tipping over and causing injury to people or pets. Install the straps snugly to the wall at the highest feasible location.