

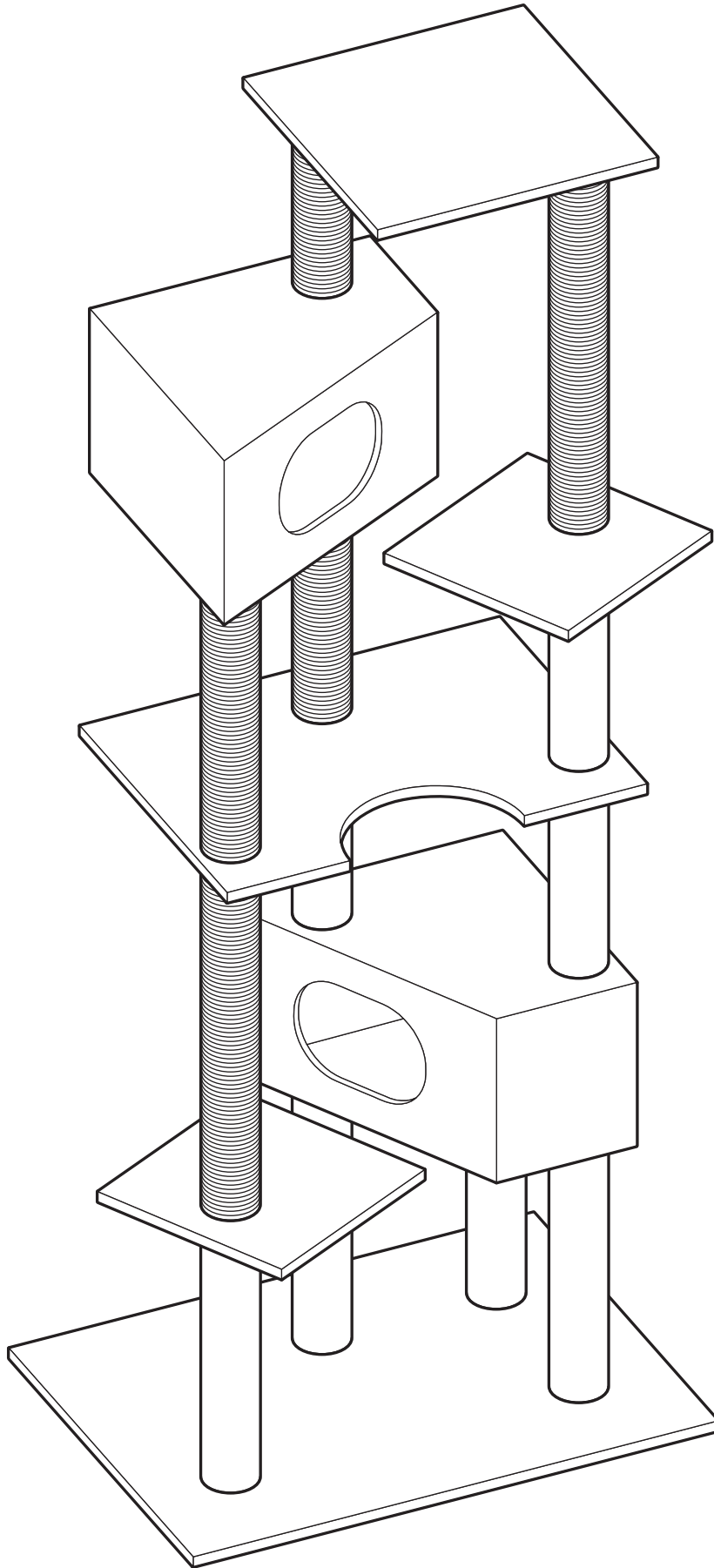

6-level cat tree

ASSEMBLY INSTRUCTIONS

Thank you for your purchase. Follow these step-by-step instructions to properly assemble your 6-level cat tree.



Be a good pet parent: read guides and books, and research quality care for your pet. Contact a pet professional with any additional care questions.

For questions and inquiries, please contact our customer service line at 1-888-824-7257. For online orders, contact us at 1-877-738-6742, or visit us at petco.com.

⚠ WARNING

- Read and follow all warnings and instructions in this manual to avoid personal injury to pet or property damage.
- This item is not suitable for children. Keep children away to avoid accidents.
- To avoid damage, do NOT assemble horizontally on the floor and lift to an upright position. Assemble product vertically as shown in instructions.
- For additional stability, we recommend placing product against wall or corner.
- Inspect product regularly and re-tighten screws as necessary.
- Always supervise your pet when using this item.
- Inspect product for damage and discard if any part becomes worn, loose or detached.
- As with most furniture, do not place in direct sunlight and/or damp area. May cause discoloration and potential rust on metal surfaces. It is normal for rope wrapped posts to discolor over time. Not recommended for outdoor use.
- Spot clean only with gentle liquid detergent mixed with water.
- Keep all tools and instructions in a safe place for future reference.

CAUTION: NOT SUITABLE FOR CHILDREN. Inspect regularly and discard if any part becomes damaged. For additional stability, we recommend placing against wall or corner. Not recommended for outdoor use. Periodically check hardware to tighten as needed.

completed cat tree

30 L x 26 W x 76 H IN (76 L x 66 W x 193 H cm)

Due to ongoing product improvements, product photo on packaging may not match finished product.

MAX WEIGHT LIMIT:
40 LB
(18.1 kg)

assembly instructions

When assembling your cat tree, place on a flat, stable surface. Assemble vertically, starting on the base.

Loose components will result in damage to the cat tree. Ensure all screws are secure and tighten them again after two days. Check that screws are secure once a month to ensure product's stability.

parts list

Tools needed are included. Check that you have all the parts shown BEFORE assembling your product. If any parts are missing, call Customer Service.

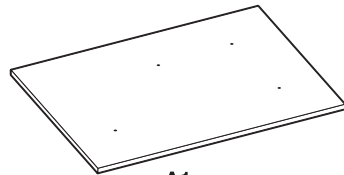

A1
Base Platform (1)

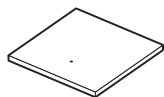

A2
Perch Platform (1)

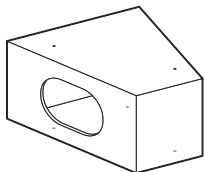

A3
Bottom Cubby (1)

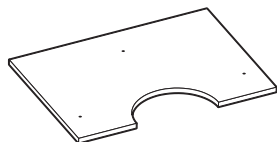

A4
Mid Platform (1)

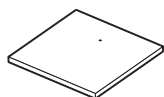

A5
Perch Platform (1)

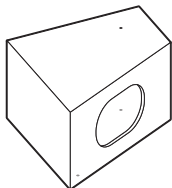

A6
Top Cubby (1)

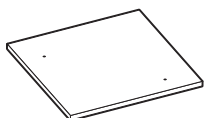

A7
Top Platform (1)

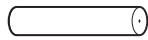

B1
Plush Post (4)

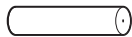

B2
Plush Post (1)

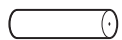

B3
Plush Post (2)



B4
Rope-wrapped Post (1)



B5
Rope-wrapped Post (1)



B6
Rope-wrapped Post (2)



B7
Rope-wrapped Post (1)

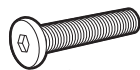

C1
Post Hex Bolt (14)



C2
Hex Bolt Wrench (1)



C3
Double-sided Bolt (5)

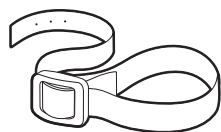

C4
Strap (1)



C5
Screw (1)



C6
Screw Anchor (1)

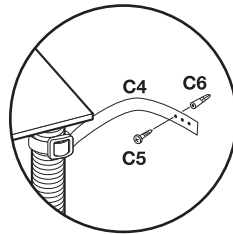

NOTE: The included wall anchor strap must be installed to help prevent the tree from tipping over and causing injury to people or pets. Install the straps snugly to the wall at the highest feasible location.

