

ASSEMBLY INSTRUCTIONS

Thank you for your purchase. Follow these step-by-step instructions to properly assemble your 5 Level Cat Tree.

PARTS LIST

Tools needed are included. Check that you have all the parts shown BEFORE assembling your product. If any parts are missing, call Customer Service.



Hex Wrench

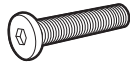

10 - 40mm Hex Bolt (1)

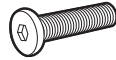

1 - 30mm Hex Bolt (2)

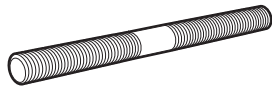

3 - 80mm Double-sided Bolt (3)

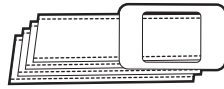

1 - Furniture Strap



1 - 30mm Screw



1 - Wall Anchor



1 - EZ-Snap™ Toy



1 - Sisal Post 22 inches (56 cm) (A)



1 - Sisal Post 17.3 inches (44 cm) (B)



3 - Sisal Post 13 inches (33 cm) (C)

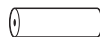

3 - Two Fleece and One Sisal 8.25 inches (21 cm) (D)

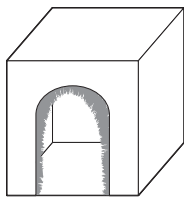

1 - Hideaway with Groomer

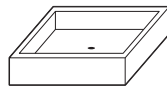

1 - Small Platform

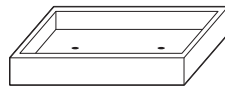

1 - Large Platform

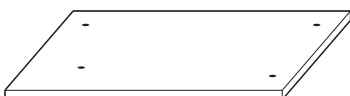

1 - Base (A)

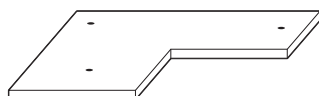

1 - L-Shaped Platform (B)

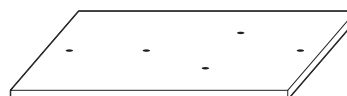

1 - Hideaway Platform (C)

Be a good pet parent, read care guides, books, and research quality care for your pet. Contact a pet professional with any additional care questions.

For questions and inquiries, please contact our customer service line at 1-888-824-7257. For online orders, contact us at 1-877-738-6742, or visit us at petco.com.

⚠️ WARNING

- Read and follow all warnings and instructions in this manual to avoid personal injury to pet or property damage.
- This item is not suitable for children. Keep children away to avoid accidents.
- To avoid damage, do NOT assemble horizontally on the floor and lift to an upright position. Assemble product vertically as shown in instructions.
- For additional stability, we recommend placing product against wall or corner.
- Inspect product regularly and re-tighten screws as necessary.
- Always supervise your pet when using this item.
- Inspect product for damage and discard if any part becomes worn, loose or detached.
- As with most furniture, do not place in direct sunlight and/or damp area-may cause discoloration and potential rust on metal surfaces. It is normal for sisal posts to discolor over time. Not recommended for outdoor use.
- Spot clean only with gentle liquid detergent mixed with water.
- Keep all tools and instructions in a safe place for future reference.

ASSEMBLY INSTRUCTIONS

When assembling your cat tree, place on a flat, stable surface. Assemble vertically, starting on the base.

The EZ-Snap® Toy included can be attached to different areas of the cat tree. You also may purchase additional Leaps & Bounds™ EZ-Snap Toys® separately at Petco.

Loose components will result in damage to the cat tree. Ensure all screws are secure and tighten them again after two days. Check that screws are secure once a month to ensure product's stability.

COMPLETED CAT TREE

21.5 W x 27.5 D x 54 H inches
(54.6 W x 69.9 D x 137.2 H cm)

Due to ongoing product improvements, product photo on packaging may not match finished product.

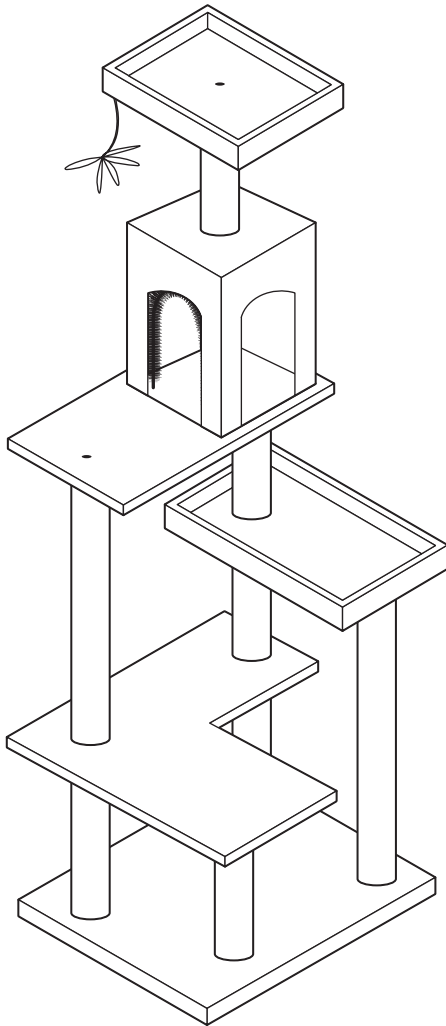

Assemble vertically, starting on the base.

NOTE: The included wall mount must be installed to help prevent the tree from tipping over and causing injury to people or pets.

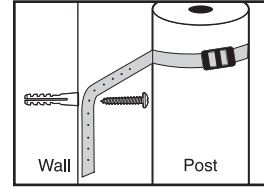

Hideaway with Groomer

Platform C

Platform B

Base A

Small Platform

Attach EZ-Snap® Toys

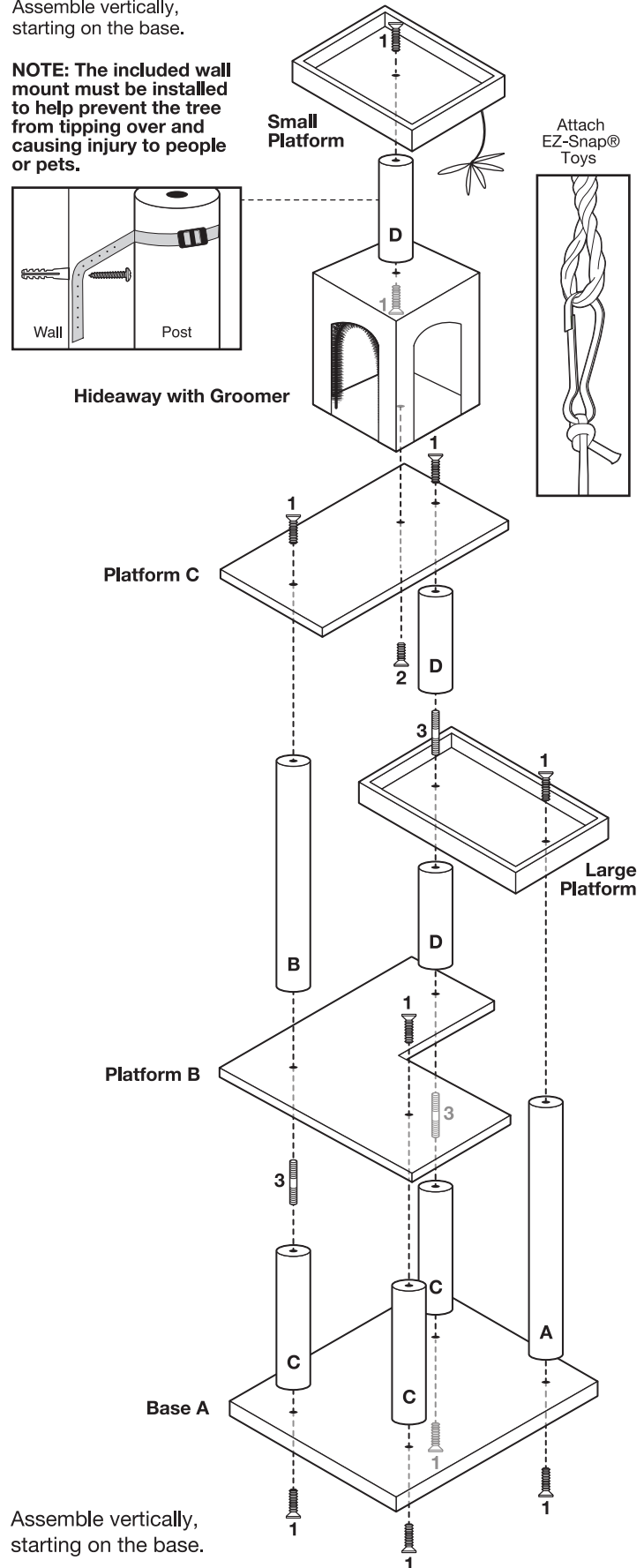

Assemble vertically, starting on the base.